

MASTERLINE 10-HI+ DECO DOORS INWARD

OPDEKDEUR
FENETRE PORTE
REBATED DOOR
FENSTERTUER

10..

MASTERLINE 10-HI+ GETEKEND
MASTERLINE 10-HI+ DESSINE
MASTERLINE 10-HI+ DRAWN
MASTERLINE 10-HI+ GEZEICHENET

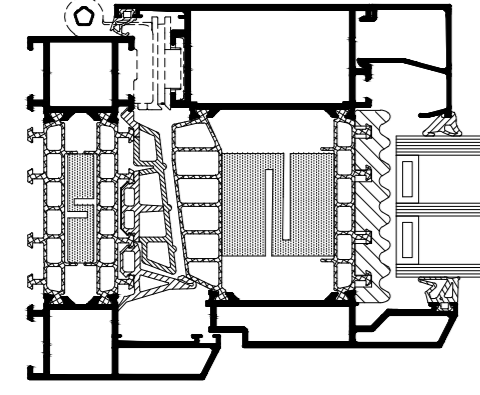

OVERZICHT OPENINGS TYPES
APERÇU TYPES D'OUVERTURE
OVERVIEW OPENING TYPES
ÜBERSICHT ÖFFNUNGSARTEN

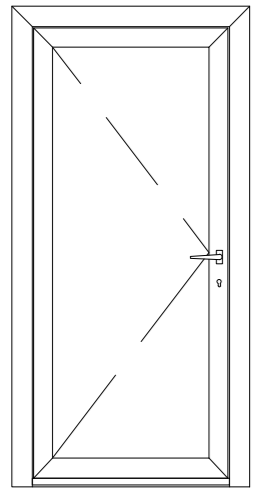
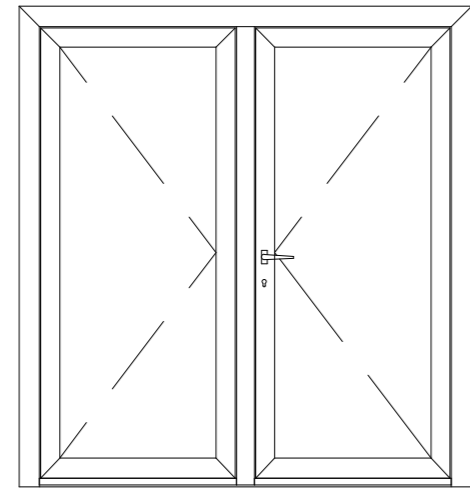
<p>DEUR BINNENDRAAIEND PORTE OUVRANT VERS L'INTERIEUR DOOR INWARD OPENING TUER NACH INNEN OEFFNEND</p>  <p>101a</p>	<p>DUBBELE DEUR NAAR BINNENDRAAIEND PORTE DOUBLE OUVRANT VERS L'INTERIEUR DOUBLE DOOR INWARD OPENING ZWEIFLUEGELIGE TUER NACH INNEN OEFFNEND</p>  <p>102a</p>
--	--

PROFIELOVERZICHT
APERÇU DES PROFILES
PROFILE OVERVIEW
PROFILUEBERSICHT



HULPPROFIELEN
PROFILES DE RACCORDEMENT
ADDITIONAL PROFILES
ZUSATZPROFILE



BOUWAANSLUITINGEN
RACCORDEMENTS AU BATIMENT
BUILDING CONNECTIONS
BAUANSCHLUESSE



101a

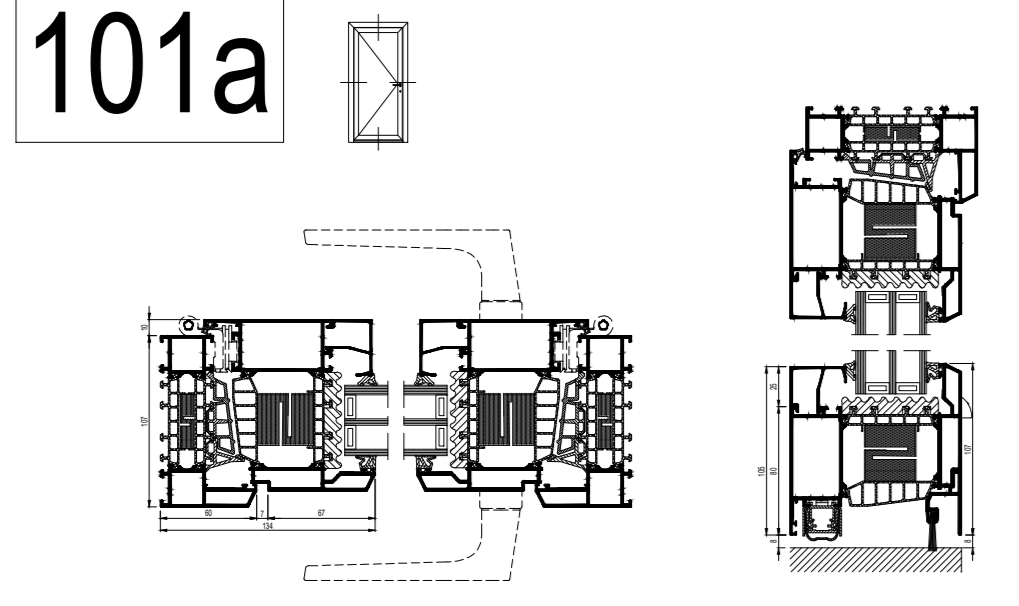

102a

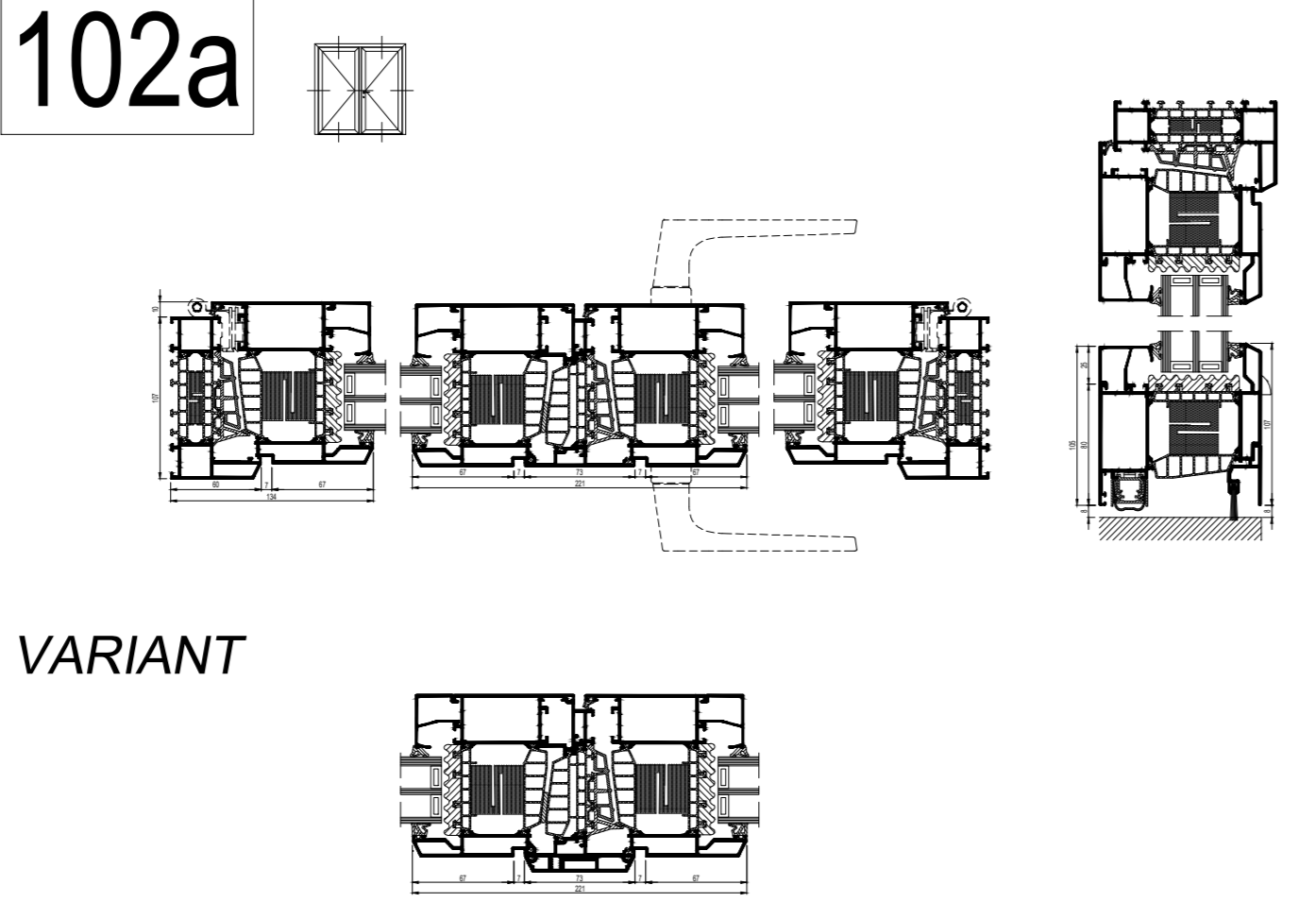

VARIANT

PROFIELOVERZICHT
APERÇU DES PROFILES
PROFILE OVERVIEW
PROFILUEBERSICHT

BUITENKADER DECO
DORMANT DECO
OUTER FRAME DECO
BLENDRAHMEN DECO

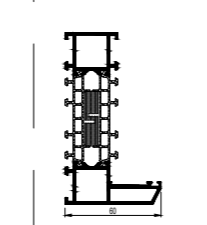

BUITENKADER
DORMANT
OUTER FRAME
BLENDRAHMEN

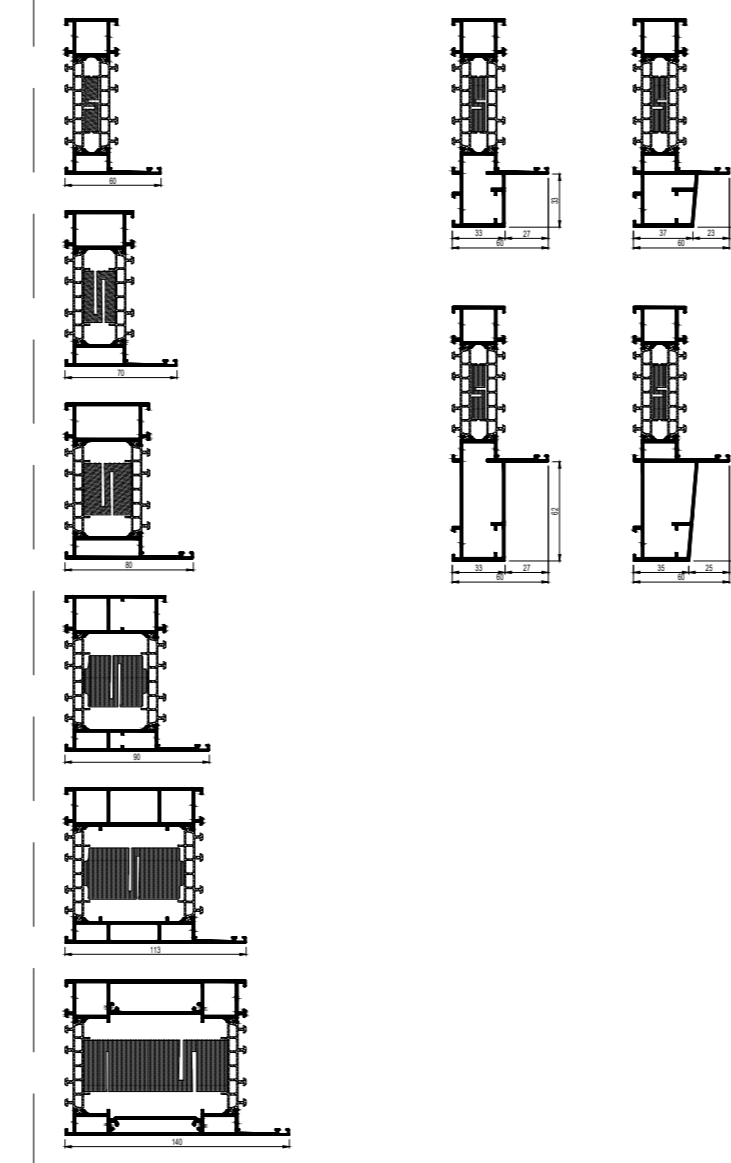

VLEUGEL
OUVRANT
VENT
FLEUGEL

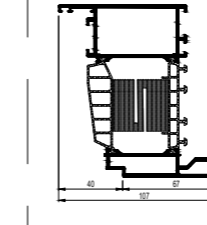
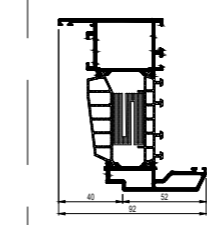
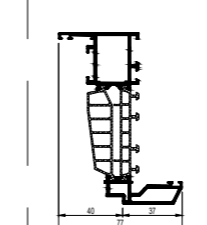

STOLPPROFIEL
BATTEE CENTRALE FEN. DOUBLE OUVR.
DOUBLE CASEMENT PROFILE
STULPPROFIL

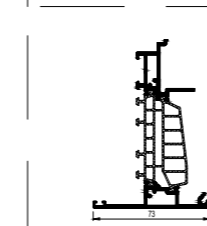

T-PROFIEL
TRAVERSE
TRANSOM-MULLION
SPROSSE

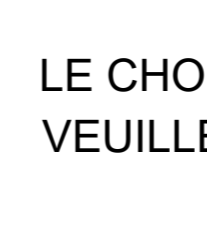
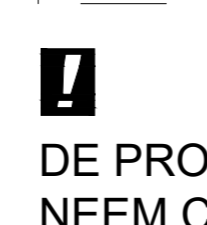
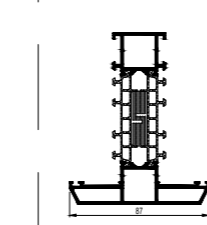

DE PROFIELKEUZE WORDT BEPAALD DOOR DE MAXIMALE AFMETINGEN EN HET MAXIMALE GEWICHT VAN HET ELEMENT.
NEEM CONTACT OP MET UW REYNAERS ALUMINIUM FABRIKANT OM DE JUISTE PROFIELKEUZE TE BEVESTIGEN.

LE CHOIX DU PROFILÉ EST DÉFINI PAR LES DIMENSIONS MAXIMALES ET LE POIDS MAXIMUM DE L'ÉLÉMENT.
VEUILLEZ CONTACTER VOTRE FABRICANT REYNAERS ALUMINIUM POUR CONFIRMER LE BON CHOIX DE PROFILÉ.

THE PROFILE SELECTION IS DEFINED BY THE MAXIMUM DIMENSIONS AND WEIGHT OF THE ELEMENT.
PLEASE CONTACT YOUR REYNAERS ALUMINIUM FABRICATOR TO CONFIRM THE RIGHT PROFILE SELECTION.

DIE PROFILAUSSWAHL WIRD DURCH DIE MAXIMALEN ABMESSUNGEN UND DAS GEWICHT DES ELEMENTS DEFINIERT.
BITTE WENDEN SIE SICH AN IHREN REYNAERS ALUMINIUM HERSTELLER UM DEN RICHTIGEN PROFILAUSSWAHL ZU BESTÄTIGEN.